

SECTION A-A
(REFERENCE CUT)

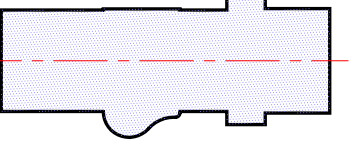

SECTION B-B
(REFERENCE CUT)

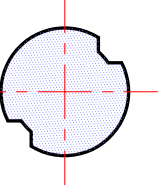

SECTION C-C
(REFERENCE CUT)

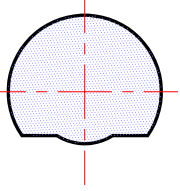

SECTION D-D
(REFERENCE CUT)

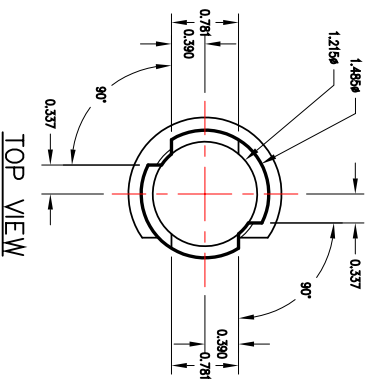

TOP VIEW

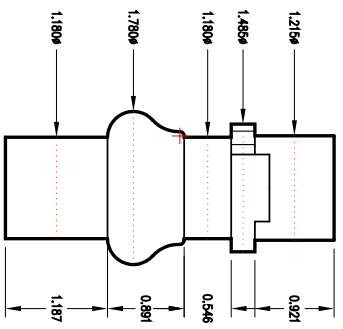

FRONT VIEW

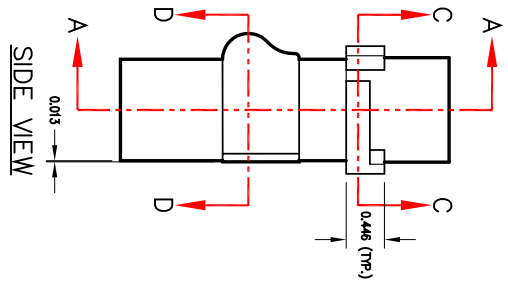

SIDE VIEW

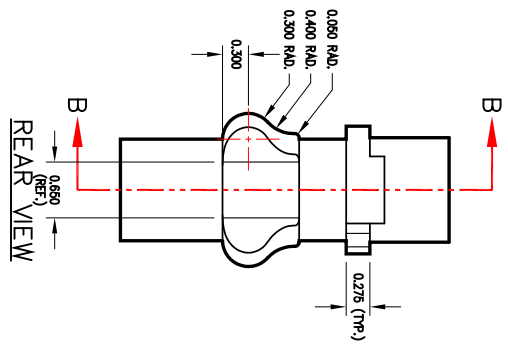

REAR VIEW

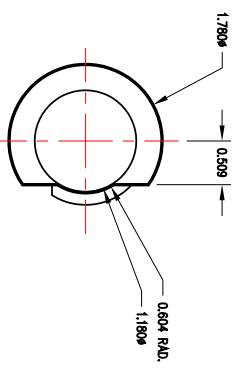

BOTTOM VIEW